



FAKRO
ROOF WINDOWS
AHEAD OF THEIR TIME



FAKRO ROOF WINDOWS AHEAD OF THEIR TIME



FAKRO has been demonstrating its commitment to producing pioneering, high quality products for over twenty years. By innovating we have continued to design products which became the industry standard and make people ask for them by name. In effect, we have consistently brought the future into the present day. When designing new roof windows, we take account of every conceivable factor which might affect a user. FAKRO roof windows have been designed not only for comfort and ease of use but style and functional efficiency.

FAKRO designs provide a large glazing area and have made our windows the most efficient in terms of provision of natural daylight. In addition to greatly enhancing the loft space environment, innovative aspects of our windows such as an automatic air inlet ensure that the optimum level of fresh air is provided without unnecessary heat loss. The pioneering top-Safe® system greatly increased the standard of burglary resistance. The use of environmentally sustainable technologies has enabled us to create the most thermally efficient roof window with single glazing unit in the world - the FTT U8 Thermo.

This combines an exceptionally low overall U-value with the use of eco-friendly insulation, and air tight flashing.

V40P



Such is our confidence in the quality of FAKRO products, that we can offer long-term guarantees of performance.

10 year warranty for window

20 year warranty for glazing unit

∞ Lifetime glazing unit hail resistance warranty



Fakro the first roof windows on the market to be TUV certified.



We are present in
47
countries
around the
world



Large
glazing
area



The operating handle in the bottom part of the sash is always within easy reach

AMPLE NATURAL LIGHT

Optimise the effects of natural daylight and sunlight for the best living environment



Design of FAKRO roof windows provides appropriate illumination of room within the loft space. Specially shaped profiles of the frame and sash as well as air inlet location in the upper part of the frame allows for the influx of high amount of natural light. FAKRO proSky roof windows offer extended height thereby ensuring superior room illumina-

tion and effective light distribution. The higher the window is installed, the better the room lighting and with the handle in the bottom of the sash, the window can be installed correspondingly higher. The recommended installation height for a roof window's top edge in accordance with DIN 5034-1 is 220cm above floor level. With the handle in the bottom of

the sash, even a tall person can stand comfortably by an open window, even a centre pivot one. FAKRO **proSky** windows, which offer the tallest heights on the market, offer extended height and a raised pivot point which guarantee an unobstructed field of view.



The most
**energy
-efficient**
roof window
in the world*
since 2011

*with single glazing unit.



The XDK Kit

- a highly effective way to ensure that the gap around a roof window is insulated effectively.

HIGH ENERGY-EFFICIENCY

Heat, like a treasure, needs to be protected!



With buildings being designed to provide the lowest possible operating costs, the FAKRO range includes many highly energy-efficient products such as the FTP-V U5, FTT U6 and FTT U8 Thermo, with U-values as low as 0.58W/m²K. The FTT U8 Thermo is the most energy

-efficient roof window with single glazing unit in the world and is used in conjunction with the specially designed EHV-AT Thermo flashing. The FAKRO approach to energy efficiency does not stop at providing roof windows with good U-values. It also involves

the provision of special packages of insulation flashings, and 'warm' Thermo flashings with additional insulation. FAKRO offers solutions which guarantee savings on heating costs.



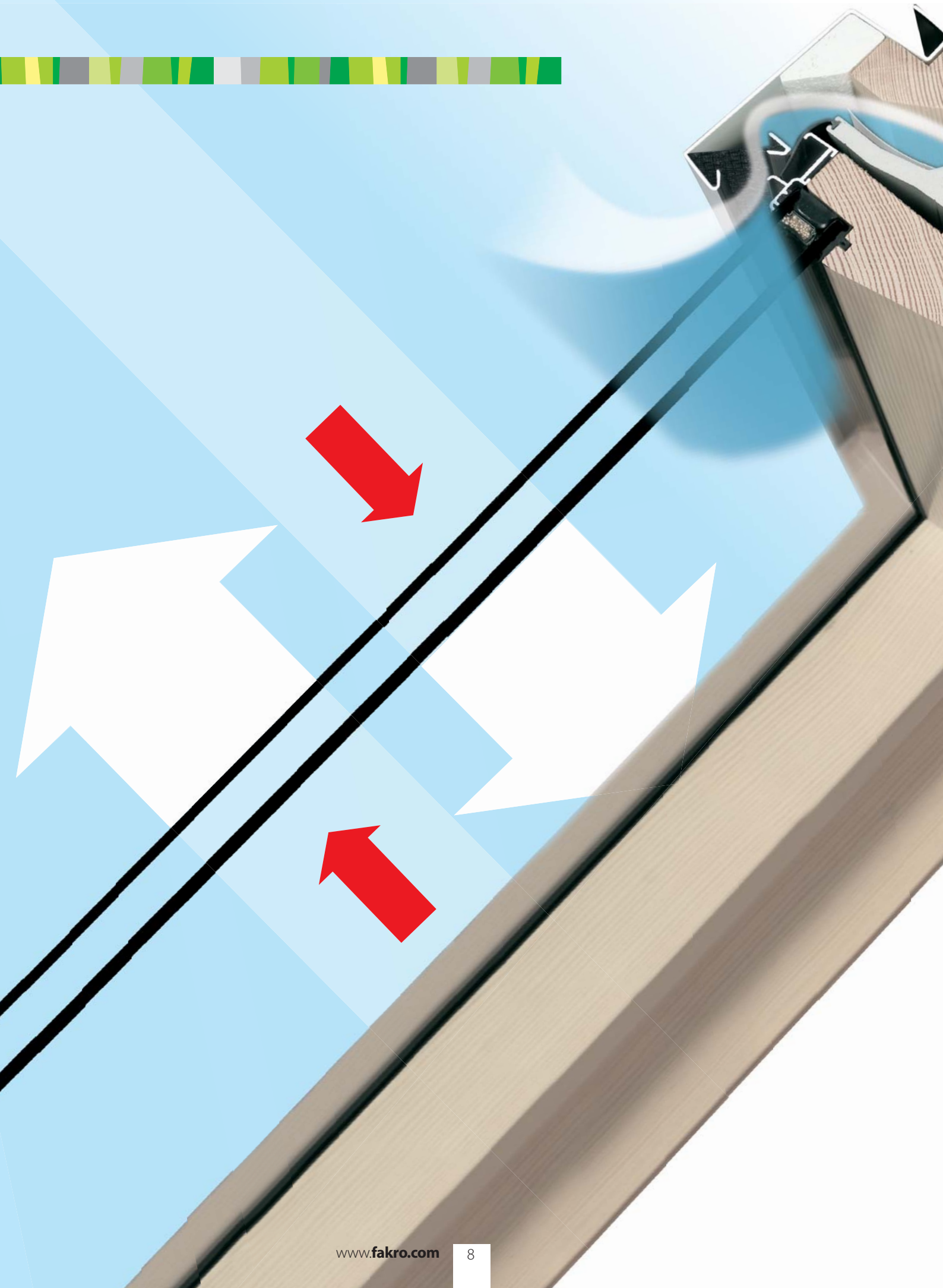

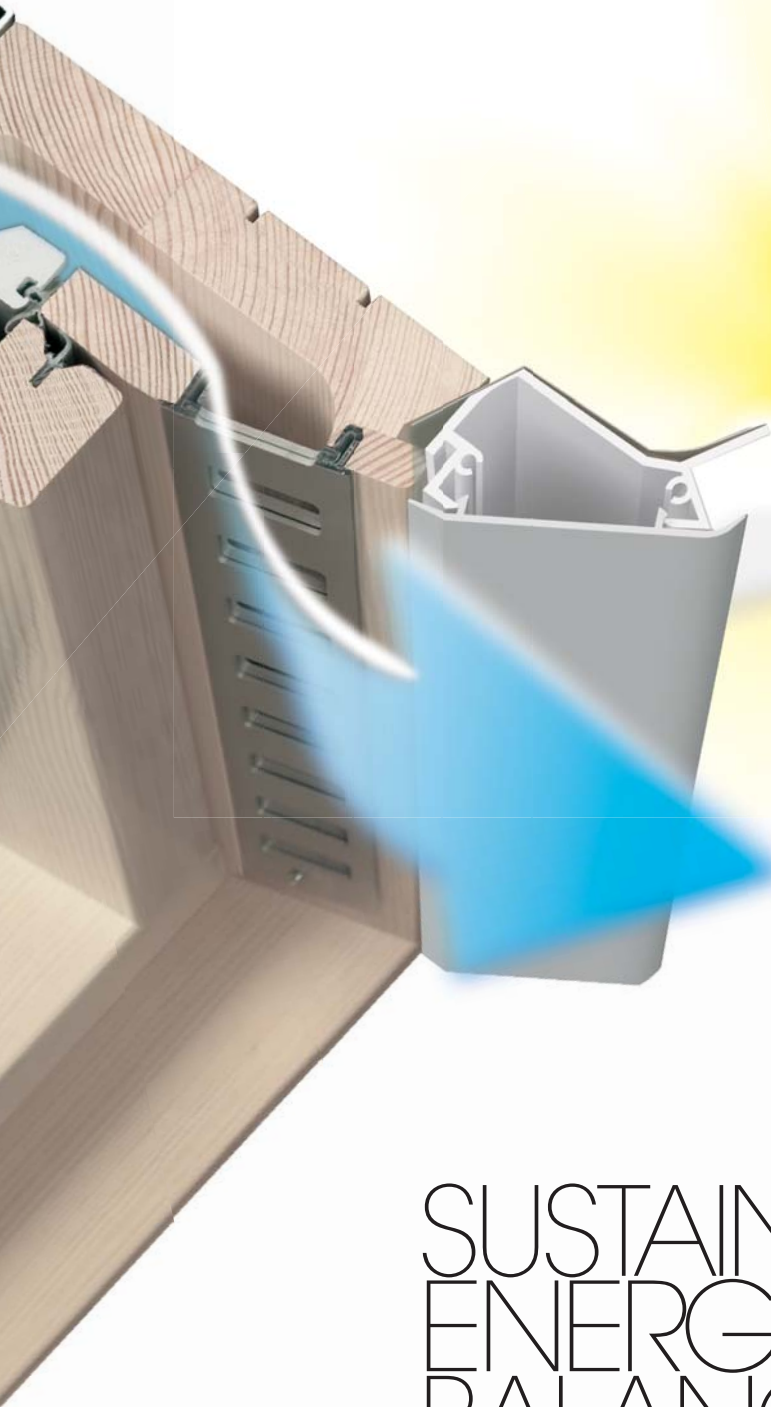

SUSTAINABLE ENERGY BALANCE

Reducing unnecessary heat loss



In addition to providing an effective light source, roof windows also act a means of passive heating in winter. The larger glazed area provided by FAKRO windows is correspondingly more effective in this

respect, with the free thermal energy being retained by virtue of their energy-efficient design.

Roof windows can also be used as a source of fresh air and with the **V40P automatic air inlet**,

the optimum amount of fresh air creates a healthy microclimate while avoiding heat loss. Fakro roof window design provides a sustainable balance in terms of air quality and energy saving.

EASY AND VERSATILE INSTALLATION SYSTEM

Simple, efficient and flexible



Proper installation is key to a roof window's long-term performance. For over 10 years, FAKRO has used mounting brackets which enable windows to be fitted to either battens or rafters. They can also be installed at **three distinct depths**. 'Higher' window installation at the N level

(3cm higher than standard) in conjunction with Thermo flashing makes the window sit higher within the roof line. Such installations perform better during adverse weather, particularly in situations of high snowfall. Setting the window deeper in the roof (the J level – 3cm lower than standard)

reduces heat loss. The improved aesthetics are particularly noticeable with slate and plain tile roofs and can be a significant factor in conservation areas. The use of special packages of XDK insulation flashings provides for quick and correct insulation around the window.

Two options for roof window installation

Installation on rafters



Installation on battens



Three depths of installation

Installation at +3cm

N

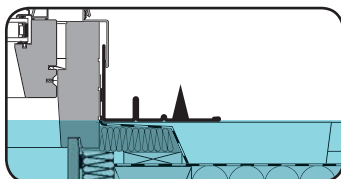

Installation at 0cm

V

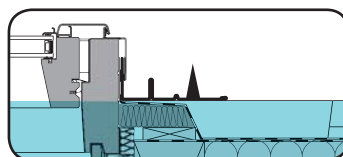

Installation at -3cm

J

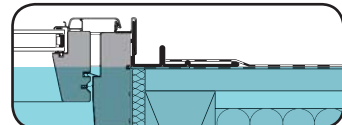



Up to
6cm*
deeper
mounting
since 2000



* In comparison to mounting at N depth



UNIQUE SYSTEM of window re-enforcement **topSafe**[®]

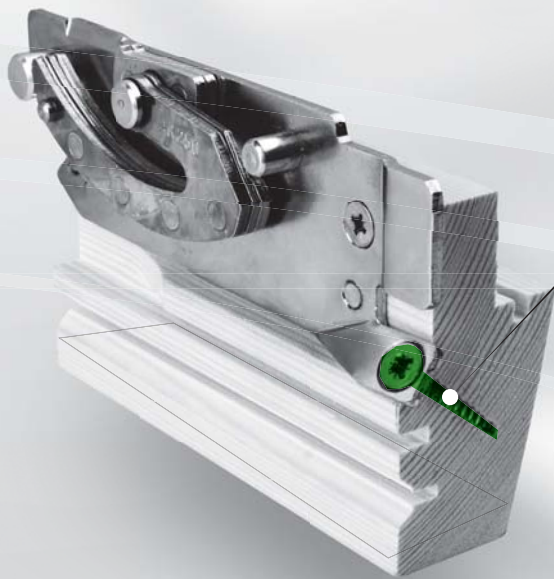

Innovative system of specially shaped and mounted hinges prevents timber splitting or forcing of the hinges and sash. This solution is several times stronger than any previously developed or used.



Metal reinforcement makes break-in using a crowbar much more difficult

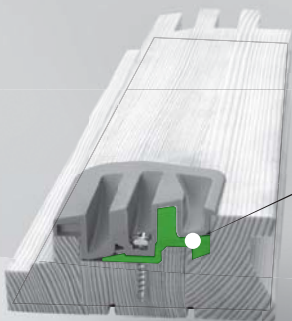

Specially reinforced structure and locking parts.

SAFETY & SECURITY

We want to feel safe at home



Roof windows must provide effective protection against potential intruders. FAKRO roof windows have been designed to provide the highest sense of security and are equipped with the pioneering topSafe® system of reinforcement. Used in conjunction with toughened external glass, the system significantly improves the resistance to break-in attempts and pro-

tests against the sash opening if inadvertently stepped on. This has enabled all FAKRO products to meet a minimum Class III - EN13049, another standard which FAKRO was first to achieve.



new

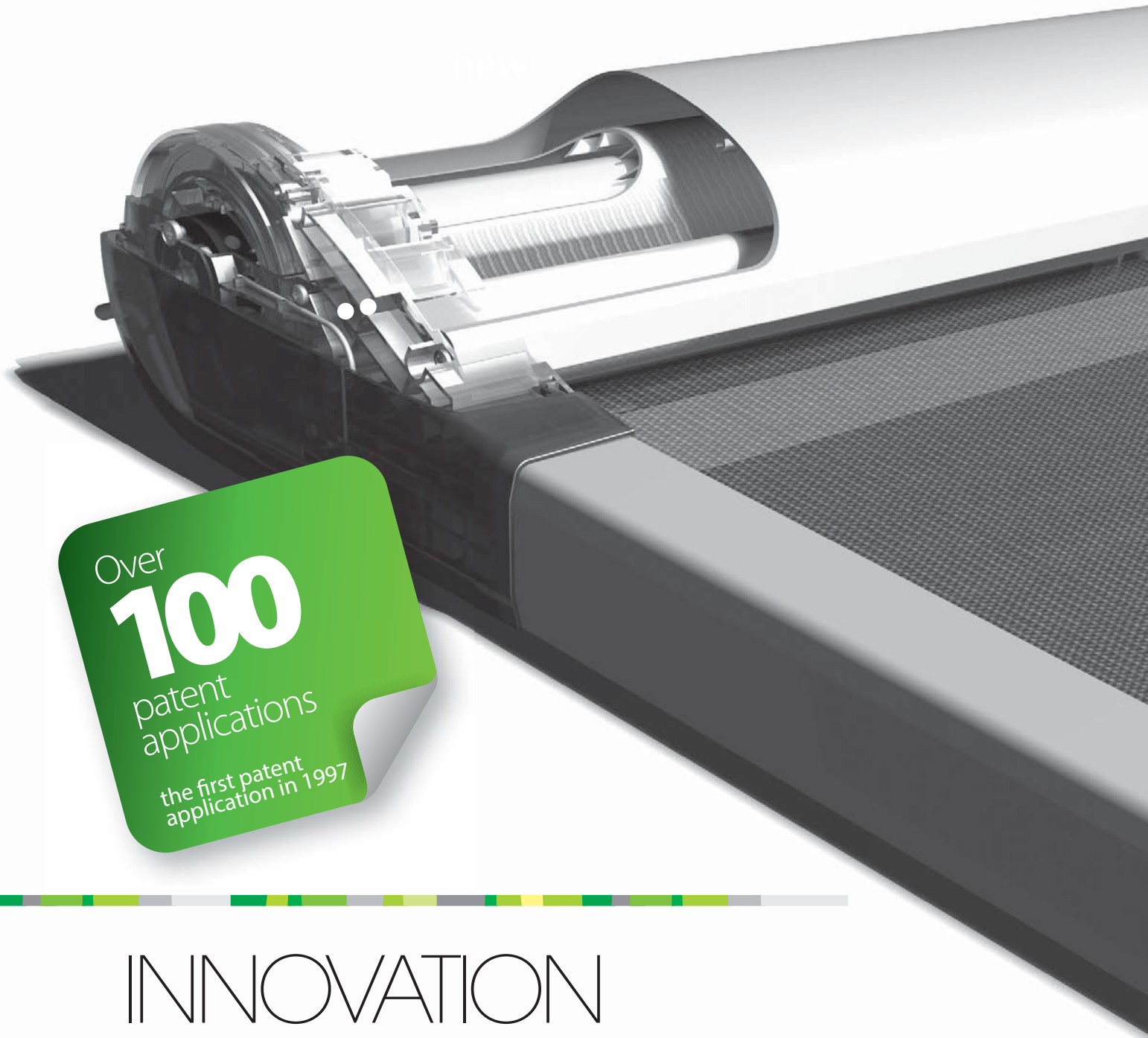

Over
100
patent
applications
the first patent
application in 1997

INNOVATION

Creativity changes the world



Innovation is at the heart of all FAKRO research and development. At our modern R & D centre, we always seek to create unique products and innovative solutions. In addition to the

topSafe® system, other industry leading developments have included the preSelect® top hung and pivot window and the proSky high pivot window. Innovation has become a key

driver for the company and as a result FAKRO holds more than 100 patents and patent applications.



The new generation **preSelect**[®] roof window offers two distinct means of opening the sash. It can be used as either a top hung or centre pivot window, with both offering complete stability and improved safety. Changing from top hung to centre pivot operation is achieved simply by use of a preSelect[®] switch in the frame. This activates a unique system of hardware while ensuring that both functions remain independent of each other.



The **FGH-V Galeria balcony window** has twin sashes which create a balcony when opened. The upper top hung sash opens upwards, while the lower sash tilts outwards allowing easy access to the balcony opening. Balustrades are an integral element of the bottom sash and when closed are hidden in the window, with nothing visible above the roof line. As a result there are no obtrusive elements of cladding to collect dirt and leaves which would spoil the aesthetic of the roof line.



When designing the antiburglary **Secure** window, we took the concept of burglary protection to another level. In addition to using topSafe[®], the window is equipped with a system which prevents removal of the glazing unit and uses an anti-burglary internal pane Class P2A. Our 'Secure' windows do not require additional locks and are therefore more aesthetically stylish and functionally efficient.

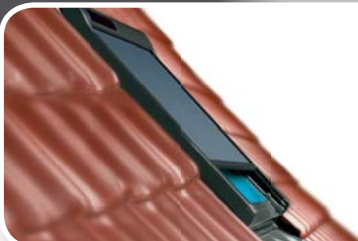

The FAKRO **Electric awning blind provides** exceptional ease of use. It is operated by remote control either to provide a light screen in an instant or position it at any point. Our solar awning blind is fully automatic, depending on the degree of insolation.



HIGH AESTHETIC VALUE

Form does matter





Roof windows are now frequently used as an intrinsic element of contemporary interior design. All FAKRO roof windows offer a critical combination of quality,

functionality and visual appeal. Great care is taken to ensure that the highest standard of manufacturing goes hand in hand with attention to styling to suit any interior design style.

From an exterior perspective, profiles are both modern and compatible with any roof structure or pitch.

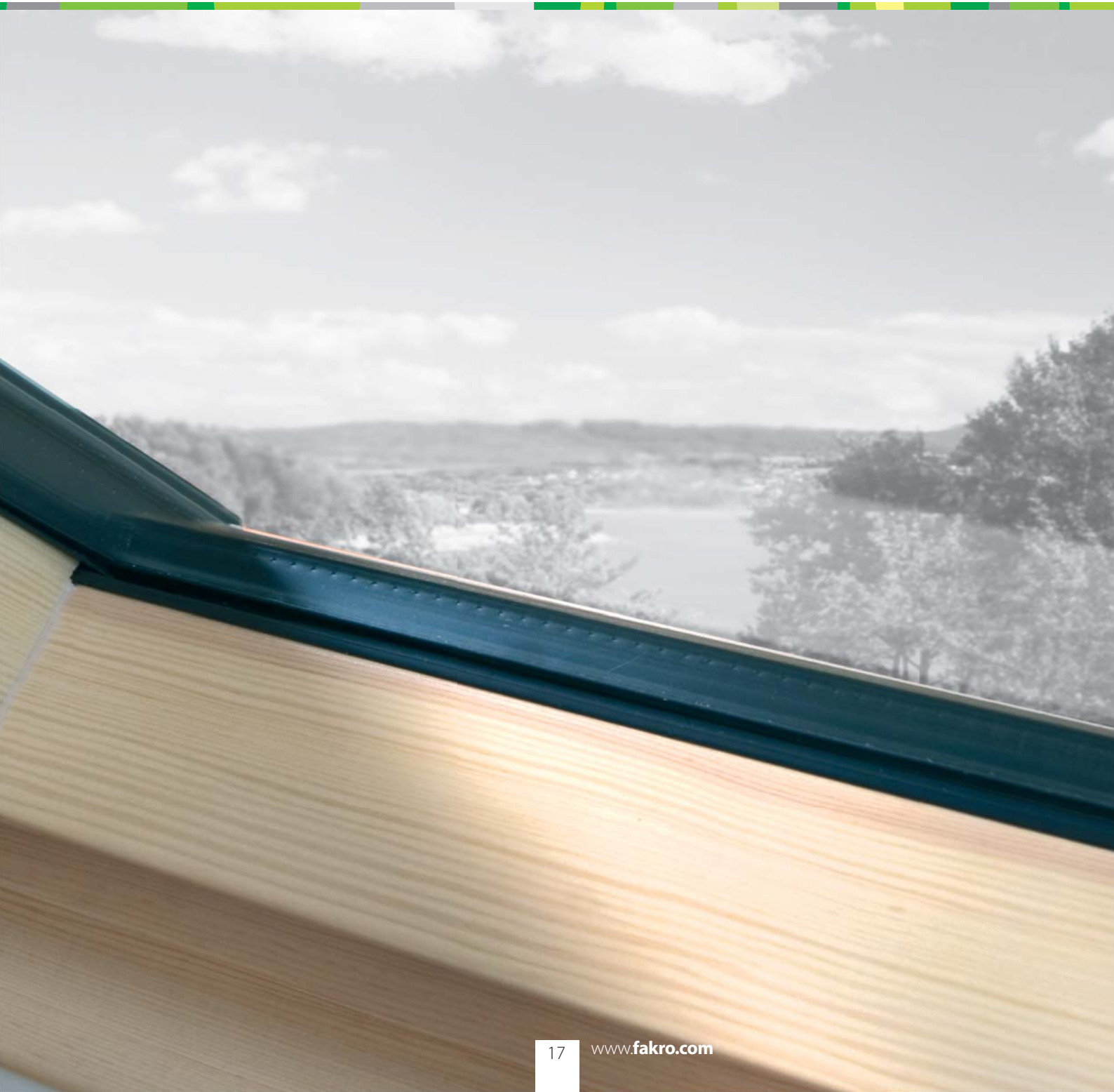

SOLUTIONS

not offered by others

In addition to placing heavy emphasis on aesthetics, a key requirement of any FAKRO product is that it should offer the highest standard of durability. FAKRO roof windows have been designed to function effectively in the harshest environments to a standard which others either do not offer or have been slow to introduce.



A system for which a patent is pending relates to special locks used in FAKRO roof windows which protect the glazing unit against unauthorized removal. Other manufacturers may offer only laminated glass which can be removed simply by undoing the retaining profiles.



Protection of corners is currently the subject of a further patent application in which the technology of joining window profiles makes FAKRO roof windows perform even in the most extreme weather conditions. Unlike other competitors' roof windows (particularly white windows), no cracks will form in corners.

FAKRO



OTHER WINDOWS



'Profi' class roof windows have been equipped with an **additional glazing seal** which improves airtightness even under the most extreme weather conditions. The seal also provides enhanced acoustic performance.

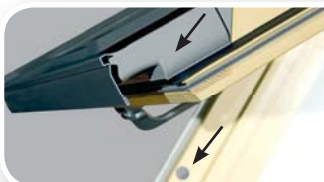

A sash guiding system ensures optimum contact between seals and profiles while enabling the window to be installed or removed quickly without taking out the sash.

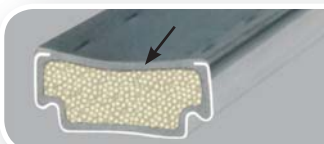

Warm TGI spacers reduce thermal bridging, thereby minimizing condensation on either glass or timber and greatly increasing the **durability of the timber**.



Vacuum impregnation of the timber is several times more effective than immersion. FAKRO roof windows are vacuum impregnated with exposed surfaces also being finished with successive coats of a durable lacquer to provide lasting protection and appearance.



ECOLOGY

The environment and sustainability



In terms of environmental impact, FAKRO products are designed to provide the highest standards of thermal efficiency while being manufactured using replenishable natural resources. Low profile solar

panels can also be used in modular form with FAKRO roof windows to enable free energy to be harvested. Ecological considerations extend to the sustainable use of other raw materials in conjunction with



management planning and rational waste management in the production process.

www.fakro.com

